

NOTE:
 MAXIMUM DISTANCE FROM ADAPTER
 TO SOLENOID VALVE 450'

- 1 4-ZONE DECODER MODEL
NO ACC-DCR-004
- 2 24 VAC SOLENOID VALVE
(1 OF 4)
- 3 10" ROUND VALVE BOX (1
OF 4)
- 4 DBY WATER PROOF
CONNECTION (1 OF 10)
- 5 2-WIRE COMMUNICATION
CABLE IN CONDUIT
- 6 EARTH GROUND

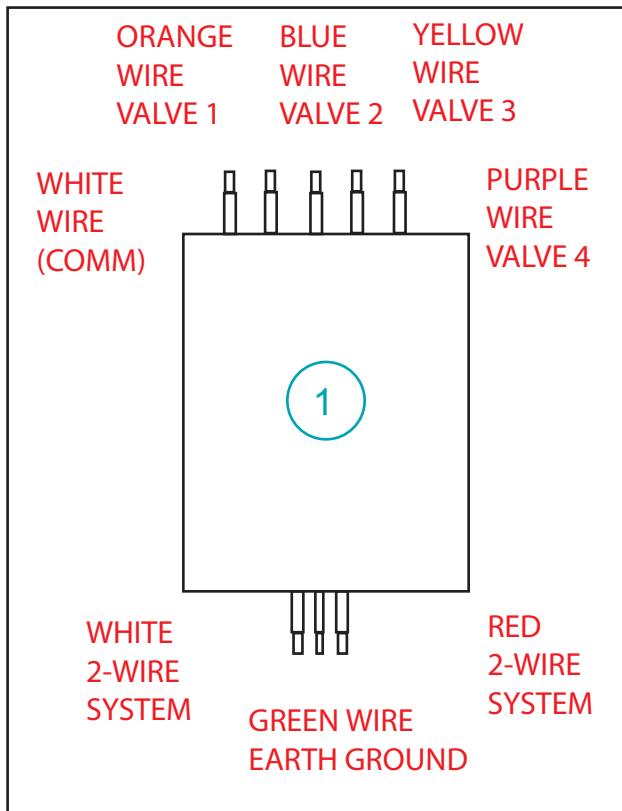

A

TYPICAL 4-ZONE DECODER ACCLIMA ACC-DCR-004

STANDARD DETAIL-NO-SCALE
 3-13-09